

# DIY Woodfired Ovens

The finished size of the ovens is the minimum size for the bases. The bases can be made from bricks, limestone, steel or timber as long as they will support the ovens. An 80-100mm concrete slab is best for the top, but a strong 15-20mm thick fibre or concrete board or boards (the thicker the better- use 2 boards thick if necessary) can be used if it is well supported. Build the base bigger if you require some work space.

## Family Oven

External size with render: 1300mm wide x 1350mm long.

Front view of Family oven with suggested base design.

Please note that our base sizes are for our ovens only. Other ovens may not fit.

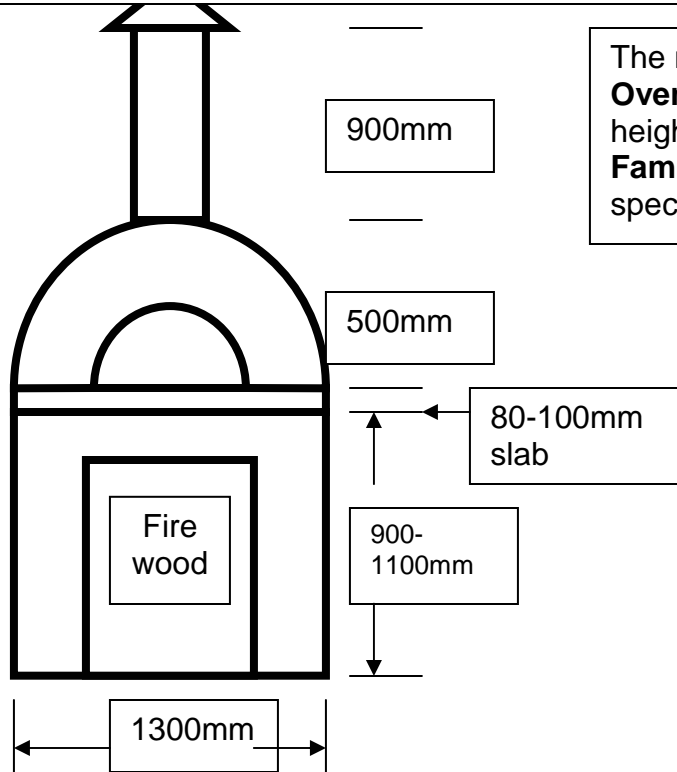

## Standard base Family

1300mm

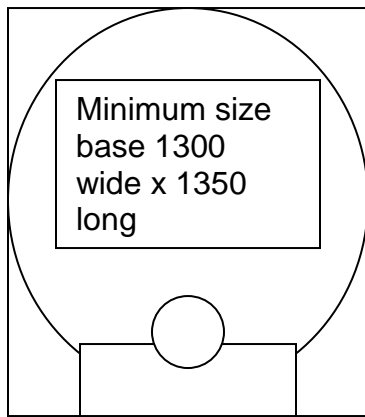

850

## Top view

1350

## Corner base Family

1500mm

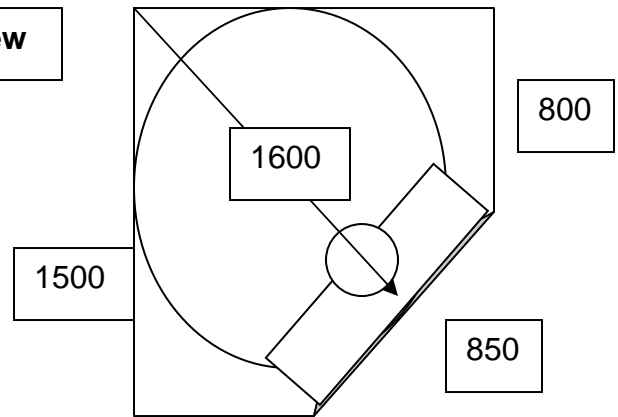

800

800

850

**Medium Napoli Oven  
Standard Base size  
Minimum Sizes**

**Medium Napoli Oven  
Corner Base Size  
Minimum Sizes**

External size, 1100mm wide  
x 1150mm long/deep.  
For extra bench space,  
make the base bigger.

